

OKDIA

2011 INTERNATIONAL OK DINGHY CLASS RULES

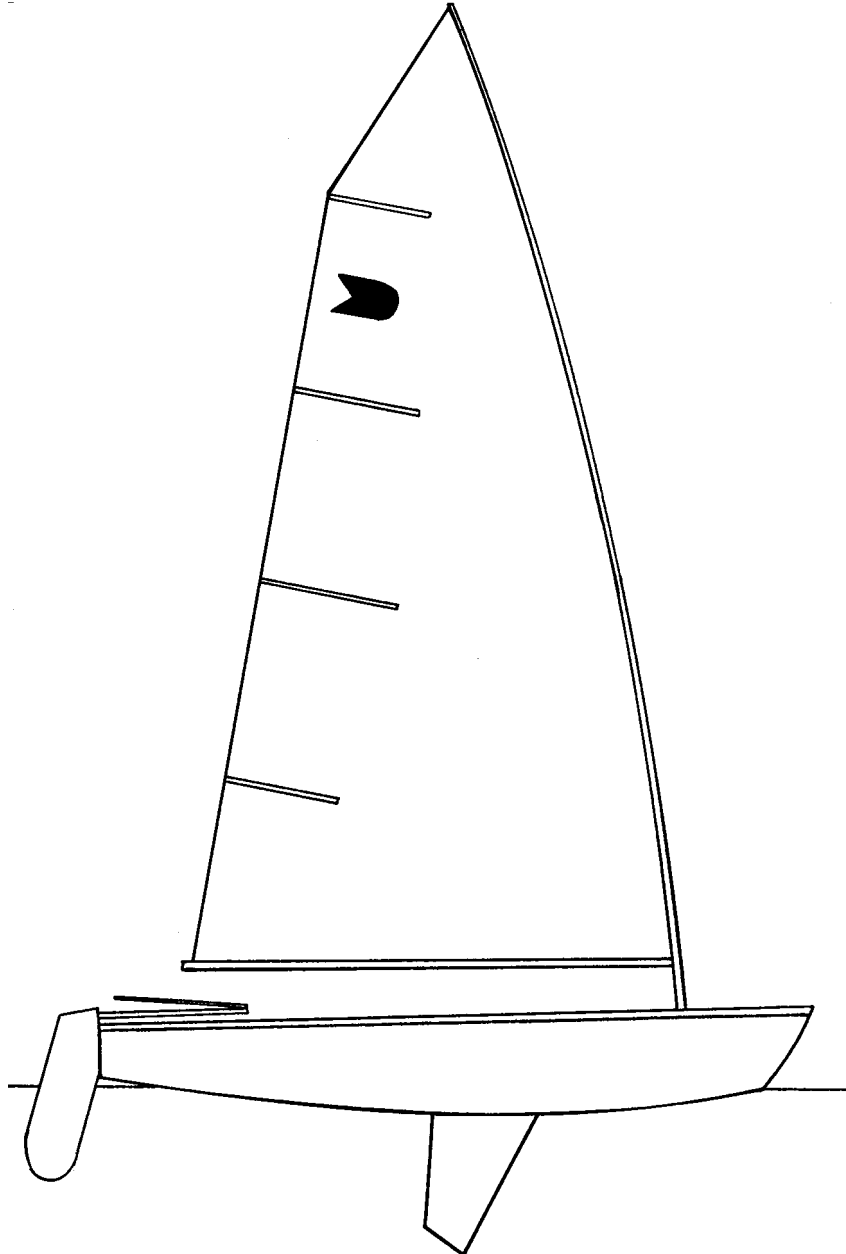

Authority*: International Sailing Federation



* The International Sailing Federation (ISAF) is not a National Authority (NA).

1. GENERAL

- 1.1 The OK Dinghy is a one-design class. The intention of these rules is to ensure that the boats are as alike as possible in all respects affecting performance. However, within these rules, variations in the construction of the boat are permitted.
- 1.2 The official language of the class is English, and in the event of dispute over interpretation the English text shall prevail.
- 1.3 These rules are complementary to the plans, measurement form and measurement diagram. Any interpretation shall be made by the ISAF which shall consult the OK Dinghy International Association (OKDIA).
- 1.4 In the event of discrepancy between these rules, the measurement form, the measurement diagram and/or the plans the matter shall be referred to the ISAF.
- 1.5 All boats shall be built in accordance with the class rules and measurement form as issued by the ISAF.
- 1.6 In countries where there is no National Authority (NA) or the NA does not wish to administer the class, its functions as stated in these class rules shall be carried out by OKDIA or its delegated representatives (National Associations). Where the NA has delegated the administration of the class to the National Association the words "National OK Dinghy Association" replace the words "National Authority" in the following rules.
- 1.7 Neither the ISAF nor OKDIA accept any legal responsibility in respect of these rules and/or the plans or any claim arising therefrom.

2. BUILDERS

The OK Dinghy may be built by any professional or amateur builder; no building licence is required.

3. BUILDING FEE

- 3.1 The building fee shall be subject to review by ISAF and OKDIA
- 3.2 The amount of the International Class Fee may be reviewed by the ISAF in consultation with OKDIA.
- 3.3 OKDIA is responsible for the collection and distribution of building fees.
- 3.4 The building fee is payable by the builder on each boat built, whether or not it is subsequently measured and registered. Payment shall be made directly to the National OK Dinghy Association which shall issue a receipt and an ISAF plaque, both bearing the same number. The receipt and plaque shall be delivered by the builder to the owner on sale of the boat. The plaque should be fitted on the starboard side of the aft cockpit bulkhead.
- 3.5 Building fee receipts shall be valid only if made out on official receipts issued by OKDIA. The ISAF will sell these receipts for the agreed fee to the OKDIA which shall sell them for a fee approved by the ISAF to each of its National Associations. The purchase price in each case represents the proportion of the building fee due to the ISAF and the OKDIA and the National Association.

4. REGISTRATION AND MEASUREMENT CERTIFICATE

- 4.1 No boat is permitted to race in the class unless it has a valid measurement certificate.
- 4.2 The certificate is only valid for racing if the owner is a current member of a National OK Dinghy Association.
- 4.3 The certificate is obtained as follows:
- (i) The builder or owner shall apply to the National Authority for a sail number enclosing the building fee receipt. The National Authority shall issue a sail number only on receipt of evidence that the building fee has been paid.
 - (ii) The boat shall be measured by a measurer officially recognised by the NA. The completed measurement form shall be supplied to the owner of the boat.
 - (iii) The owner shall send the completed measurement form to his NA together with any registration fee that may be required. On receipt of this the NA may issue a certificate to the owner.
- 4.4 Change of ownership invalidates the certificate but shall not necessitate remeasurement. The owner may apply to his NA for a new certificate returning the old certificate together with any re-registration fee that may be required and stating the necessary particulars. A certificate shall then be issued to the new owner.
- 4.5 It is the owner's responsibility to ensure that his boat, spars, sails and equipment comply with the class rules at all times and that alterations or repairs to the boat, spars, sails or equipment do not invalidate the certificate.
- 4.6 Notwithstanding anything in these rules the ISAF or NA shall have the power to refuse to grant a certificate to, or withdraw a certificate from, any boat.
- 4.7 OKDIA shall be sent at regular intervals from each NA details of certificates issued, together with the names and addresses of the owners.

5. MEASUREMENT

- 5.1 Only a measurer officially recognised by a NA shall measure a boat, its spars, sails and equipment and sign the declaration on the measurement form that they comply with the class rules.
- 5.2 The measurer shall report on the measurement form anything which he considers to be a departure from the intended nature and design of the boat, or to be against the general interest of the class, and a certificate may be refused, even if the specific requirements of the rules are satisfied.
- 5.3 A measurer shall not measure a boat, spars, sails or equipment owned or built by himself, or in which he is an interested party or has a vested interest.
- 5.4 New or substantially altered sails shall be measured by an official measurer who shall stamp or sign and date the sails near the tack.
- 5.5 All boats in hull form and construction, spars and sails shall comply with the current rules or

with the corresponding rules applying to them at the time the original certificate was issued. Any alterations or replacements shall comply with the current rules.

- 5.6 All boats and their equipment shall be liable to re-measurement at the discretion of the NA or race committee.
- 5.7 All boats will be liable to gyration tests at the discretion of the National Authority or race committee. If necessary, additional blocks shall be attached to the boat if there is no sheerguard, or if the sheerguard is inadequate, to engage swing hooks.

6. IDENTIFICATION MARKS

- 6.1 The hull of all boats built after 1st September 1973 shall carry the sail numbers and national letters either cut out or burned into the hog or centreboard case in the cockpit, or on the bulkhead at station 2 on centreline, in figures not less than 20mm in height.
- 6.2 The sail shall carry identification marks as indicated in rule 15.4.
- 6.3 All emblems, marks and numbers shall be of a durable material and securely attached.

7. HULL MEASUREMENT

- 7.1 As many measurements as considered practical to check the shape have been listed on the measurement form, but the intention is that in all particulars the boats shall conform to the designed shape.
- 7.2 Length measurements of the hull shall be taken parallel to the base line and depth measurements perpendicular to the base line. Measurement sections including the aft edge of the transom shall be perpendicular to the base line.

8. CONSTRUCTION

- 8.1 The hull, decks and centreboard case shall be made of wood or glass fibre reinforced resin (GRP or GRE) or a combination of these materials. GRP and GRE sandwich construction, not exceeding 25mm thickness including stringers, is also permitted. Wood used shall be of durable nature.
- 8.2 Any holes in buoyancy tanks shall be made watertight and each buoyancy tank shall have at least one and not more than three inspection holes if their covers are not threaded and unlimited number if the covers are threaded, with a minimum diameter of 85mm. Each hole shall have a detachable cover capable of resisting accidental dislodgement and such covers shall be positively secured at all times when racing. Covers to holes in the bulkheads shall not extend into the buoyancy compartments by more than 200mm. Control lines passing through buoyancy compartments shall be inside watertight tubes capable of withstanding the normal wear and tear and remaining watertight. The sum total cross sectional area of these tubes shall not exceed 150 cm² and they shall be within 350mm of the centreline of the boat. Control lines passing through the bulkheads or decks shall be within 350mm of the centreline of the boat.
- 8.3 Construction of the hull, with the exception of stringers, shall be of approximately even thickness (within 10%) and density longitudinally and no attempt shall be made to

concentrate weight near mid-length, or at any other point. If it is suspected that this rule is being broken a NA may order test holes to be drilled in the skin or structure.

8.4 The following shall conform with:

- (i) There shall be three watertight bulkheads. The forward face of the aft bulkhead shall be $800\text{mm} \pm 15\text{mm}$ and the aft face of the forward cockpit bulkhead shall be $1794\text{mm} \pm 15\text{mm}$ from the lowest point of the aft face of the transom. A bulkhead at, or forward of, station 3 (2800mm from the aft face of the transom) and aft of the mast shall be fitted in all boats first measured after 1st March 1984. This bulkhead may have a hatch with a watertight cover.
- (ii) The radius between the bulkheads and the side or bottom panels of the hull shall not exceed 50mm .
- (iii) Drain holes from the forward buoyancy compartment to the cockpit through the bulkhead at station 2 ($\pm 15\text{mm}$) shall not exceed two in number, and each shall be of not more than 20mm in diameter and shall be closed while racing. There shall not be more than two drain holes into the aft buoyancy tank. They shall be made through the bulkhead at station 1 ($\pm 15\text{mm}$) and shall each be of not more than 20mm in diameter and shall be closed while racing.

The mast compartment shall drain into the cockpit through a tube of diameter not less than 10mm and not more than 20mm .

- (iv) The horizontal width of each side deck, measured from the sheerline, shall be not more than 240mm or less than 120mm .
- (v) The side deck and/or carlin shall nowhere be higher than 40mm above nor 80mm below the sheerline. Struts to support the side deck are permitted but shall not exceed a total cross-sectional area of 50cm^2 per side, measured horizontally.
- (vi) The sheerline between stations 1 and 2 shall not be convex.
- (vii) At the centreline of the mast, the deck shall be $30\text{mm} \pm 10\text{mm}$ above the sheerline. Measured athwartships the fore and aft decks shall not be concave.
- (viii) A sheerguard, not exceeding 35mm horizontally from the sheerline by 35mm vertically, may be fitted.
- (ix) Between station 3 and the transom, the radius on the chines shall not exceed 15mm .
- (x) The horizontal distance from the lowest point of the aft face of the transom to the centre of the centreboard bolt shall be $2400\text{mm} \pm 10\text{mm}$.
- (xi) Spare number.
- (xii) The mast step and deck bearing may be adjustable but shall not be adjusted while racing.
- (xiii) A keel band, minimum section 9mm wide by 3mm deep, maximum section 22mm wide by 10mm deep, of any material shall extend for a distance not less than 3500mm , measured along the keel band, from the aft face of the transom. The radius of the bow forward of a point 3500mm from the lowest point of the aft face of the

transom, measured along the base line, shall not exceed 11mm.

- (xiv) Centreboard slot rubbers are prohibited.
- (xv) Hiking pads may be attached to the side decks, provided that they fall within the measurements prescribed by rules 8.4(iv), 8.4(v) and 8.4(viii). However, notwithstanding the provisions of rule 8.4(vi) padding up to 10mm thick is permitted to cover the sheerline measured at 90° to the surface.
- (xvi) A towing eye shall be fitted to the foredeck near the stemhead.

- 8.5 With the boat set up for measuring and with the base line horizontal the transom shall be not more than 12mm out of vertical.
- 8.6 8.6 The length of the hull, excluding deck overlap but including stem band, if any, shall be 4000mm ± 10mm measured from the lowest point of the transom.
- 8.7 Measurement stations 1, 2, and 3 shall be at 800mm, 1800mm and 2800mm respectively from the lowest point of the aft face of the transom measured along the base line.
- 8.8 To check the profile of the keel, a baseline shall be positioned below the hull at distances from the bottom of the hull of 200mm at station 'O' and 28mm at station '3'. The bottom of the hull shall be the point at which the extensions of the surfaces of the panels intersect. The measurements shall be in the plane of the measurement stations.
- 8.9 A straight edge placed on the bottom panel at right angles to the centreline at stations 0, 1, 2 and 3 shall not exceed the distances from the bottom panel shown on the measurement diagram. A straight edge placed at right angles to the base line on the topside panel shall not be further than 8mm from the topside panel at any point. This measurement shall be made between the sheerline and the chine and not from the underside of the sheerguard.
- 8.10 The surface of the hull shall be checked with a flexible batten to ensure that the curvature of the hull is fair.
- 8.11 A breakwater may be fitted between the mast and the mainsheet horse or track.
- 8.12 The types, positions and arrangement of floor boards, fittings, self-bailers, sheeting and centreboard hoists are free. The mainsheet track may extend outboard to the topside panel. If the side-deck profile is cut away for this purpose the panel on which the track sits must satisfy rules 8.4(iv) and 8.4(v).

MEASUREMENT DIAGRAM

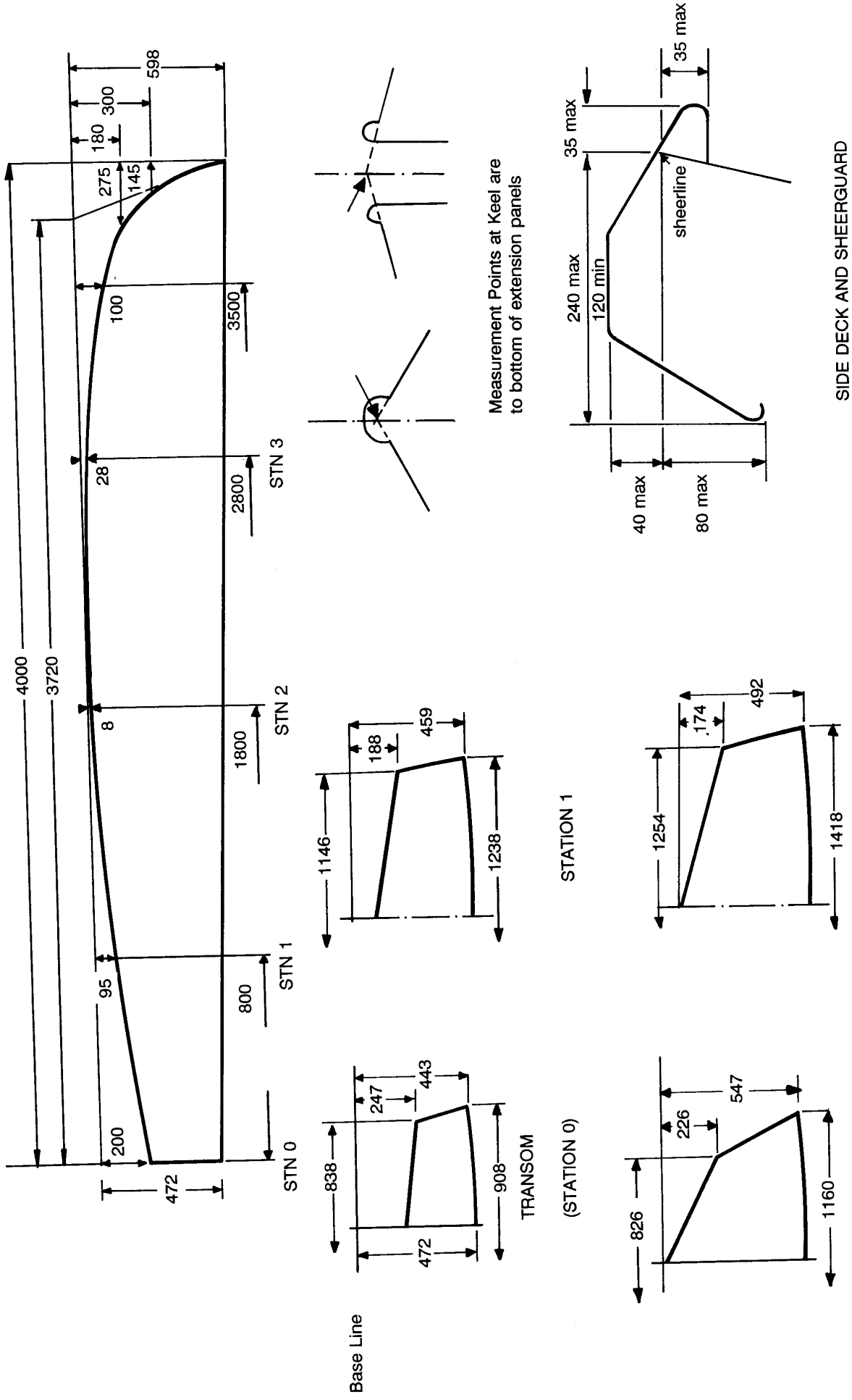

Base Line

TRANSOM

(STATION 0)

STATION 1

STATION 2

STATION 3

Measurement Points at Keel are to bottom of extension panels

SIDE DECK AND SHEERGUARD

9. BUOYANCY

- 9.1 All the space aft of the cockpit shall form a buoyancy compartment. The space forward of the cockpit shall be occupied by not less than 0.12 m³ of closed cell expanded plastic foam material properly secured. Sandwich construction shall not be regarded as buoyancy for the purposes of this rule. Wooden boats first measured before 1st March 1980 in which the space forward of the cockpit is occupied by two compartments, each not less than 0.12 m³ in volume, are not required to have 0.12 m³ of expanded plastic foam material forward of the cockpit.
- 9.2 Additional buoyancy within the cockpit area is permitted under the side decks to a point not lower than 80mm below the sheerline. This buoyancy shall not be included in the requirements of rule 9.1.
- 9.3 At first measurement the measurer shall check the watertightness of buoyancy tanks, inspection ports and drain plugs. If the buoyancy is unsatisfactory the measurer shall not sign the measurement form until successful remedial measures have been taken.

10. CENTREBOARD

- 10.1 The centreboard shall be made of metal wood and/or foam cored GRP or GRE except that a protecting strip of any material is permitted. Protecting strips shall not extend further than 20 mm inside the outer edges of the profile as defined in the measurement diagram. Wood centreboards may be covered with GRP or GRE.
- 10.2 The maximum thickness of the centreboard including any type of covering shall be 20mm, or 6mm if constructed of metal.
- 10.3 Excluding any pivot slot, the profile of the measured part of the centreboard shall be within two lines, one 5mm outside, and the other 5mm inside the profile shown on the measurement diagram, when the pivot point in the centreboard lies on the pivot point shown on the measurement diagram.
- A slot may be made between the pivot point in the centreboard and the perimeter. The slot shall be nowhere wider than 12mm. A device of adequate strength shall be fitted to prevent accidental dislodgement. Maximum free movement of the centreboard on the pivot bolt shall be 2mm in any direction.
- 10.4 When the centreboard is fully raised it shall not project below the keel bands.
- 10.5 The extension of the centreboard below the keel, excluding the keelband, shall not exceed 800mm. A stop shall be fitted to prevent this dimension being exceeded.

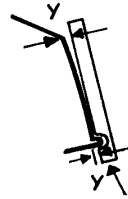
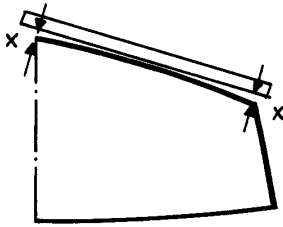

Station	Distance from bottom panel to straight edge (X in diagram)	
Transom	15mm	maximum
Station 1	25mm	maximum
Station 2	30mm	maximum
Station 3	35mm	maximum

curvature of side panel Y is not to exceed 8mm

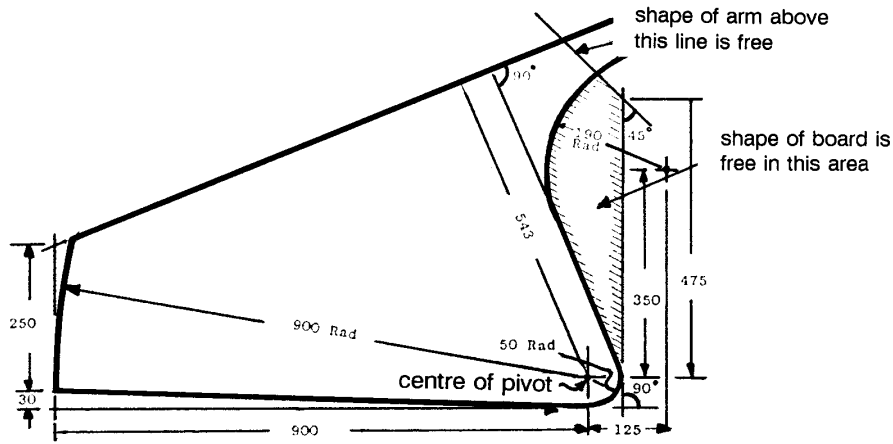
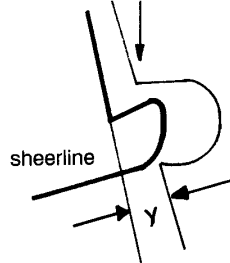

CENTREBOARD

11. **RUDDER BLADE**

- 11.1 The rudder blade shall be made of metal wood and/or foam cored GRP or GRE except that a protecting strip of any material is permitted. Protecting strips shall not extend further than 20 mm inside the outer edges of the profile as defined in the measurement diagram. The blade may be covered with GRP or GRE.
- 11.2 The thickness of the rudder blade below the waterline shall not exceed 20mm, including GRP covering (if any).
- 11.3 (a) The measured part of the rudder blade shall be within two lines, one 5mm outside and the other 5mm inside one of the two profiles shown on the measurement diagram.

(b)

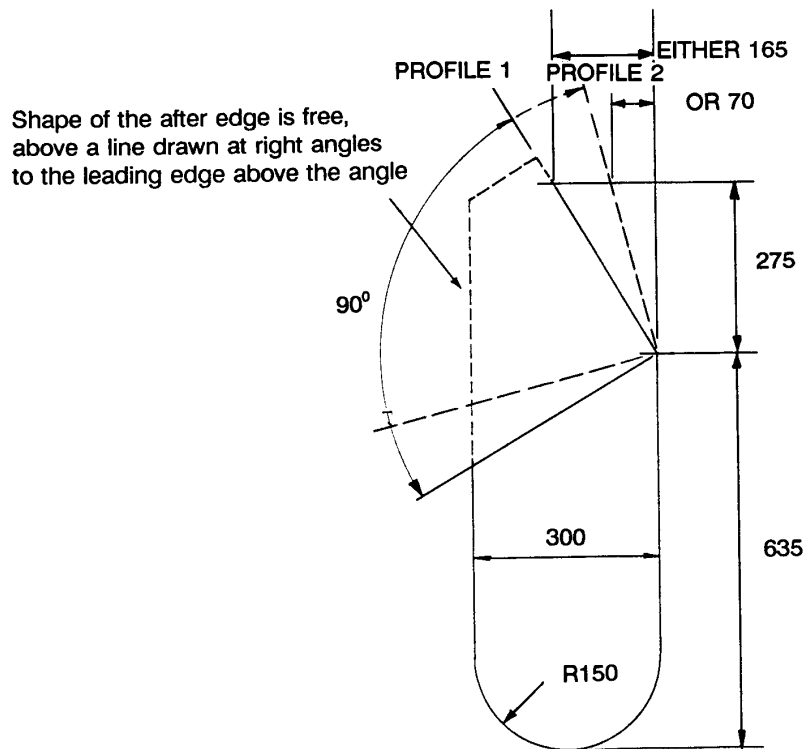

- 11.4 Lifting rudder blades shall be pinned or bolted in the down position during racing in a separate place from the point at which the rudder blade pivots.
- 11.5 The distance between the foreside of the rudder or its extension and the transom shall be measured at deck level and at the keel. Neither measurement shall exceed 45mm and the difference between the two measurements shall not exceed 5mm. The intersection of the leading edges of the rudder shall not be lower than 50mm below the transom.
- 11.6 A safety device shall be fitted so that the rudder cannot come off its pintles unintentionally if the boat is inverted.

12. MAST

12.1 Materials

The **spar** shall be made of wood, aluminium alloy, plastic or any combination of these. For the purpose of rule 12 plastic is defined as glass fibre, carbon fibre, aramid, polyester resin or epoxy resin. An external sail track may be of any material.

12.2 Construction

The construction of the **mast** is optional, with the following exceptions:

- (i) The aft side of the sail track or groove shall be constructed straight and the line of the track or groove, extended if necessary, shall be not more than 10mm outside the aft edge of the bearing ring at the deck.
- (ii) Any cross section shape of a **spar** shall be in principle round, oval or teardrop in a single geometrical figure and shall have no hollows on the outside with the exception of the sail track or groove. The inside shape shall be in principle the same as the outer shape with no additional hollows.

- (iii) Any additional internal and external tubes or webs separate to the spar construction are prohibited with the exception of the sail track.
- (iv) The wall thickness is permitted to be variable.

12.3 Fittings

With the exception of wooden **spars**, the **boom** shall be attached to the **spar** by a fixed fork fitting. The width between the arms of the fork shall be 36mm +/- 4mm. The boom pinholes shall be 16mm +/- 2mm in diameter. The centre of the holes shall be situated 37mm +/- 2mm aft of the aft face of the **spar** and 35mm +/- 2mm below the **lower point**. The bottom mast bearing may be made of any material.

12.4 Dimensions

All dimensions are given in mm.

Mast datum point at deck level² on the aft side of the spar³

	<i>Minimum</i>	<i>Maximum</i>
Lower point height above mast datum point	265	275
Upper point height above lower point		5400
Centre of gravity above mast datum point	1700	
Lower limit mark width	10	
Upper limit mark width	10mm and all above upper point	
<i>Diameter at deck level including the optional mast ring if fitted</i>	94	98
<i>Diameter at 20mm above heel point including the optional mast ring if fitted</i>	70	76
<i>Mast spar curvature at any point</i>		50
TRANSVERSE Cross Section		
<i>From heel point to 1000mm above mast datum point</i>	62	
<i>From 1000mm above mast datum point to upper point the minimum dimension is given by a uniform reduction of</i>	Minus 1 for every 100	
FOR-AND-AFT Cross Section:		
<i>From heel point to upper point the maximum dimension is given by the actual transverse width at the same height</i>		Plus 22

² as defined in 8.4(vii)

³ the aft side of the spar is given by the aft side of the sail track straightened and prolonged if necessary

12.5 Mast Spar Weight

The **mast spar weight** including, mast base, deck bearing, halyard, cleat, blocks, any **corrector weights** and excluding the goose neck pin, all in dry condition shall be not less than 8Kg.

Corrector weights totaling not more than 1.5Kg, permanently fixed to the external surface of the spar are permitted

12.6 Mast sail limit marks

The **mast sail limit marks** shall be in a contrasting colour to the **masts** colour and shall be clearly visible while racing.

12.7 Use

- (i) Movement of the **mast**, either at deck or at **heel point**, shall not exceed 7mm.
- (ii) There shall be a security device of adequate strength such that the **mast** will not come out of the step when the **boat** is capsized."

13. **BOOM**

13.1 The **boom** shall be made of wood, aluminium alloy, GRP, GRE or any combination of these materials. The sail track may be of any material

13.2 An **outer limit mark** of a distinctive colour not less than 10mm wide shall be marked on the **boom** so it is clearly discernible when racing, with its forward edge not more than 2680mm from the aft edge of the **mast spar** projected if necessary to the **boom**. A device shall be fitted to the **boom** to prevent any part of the **sail** extending aft of the forward edge of the **outer limit mark**.

13.3 The top of the **boom** including its sail track, extended if necessary, shall not be below the **lower point**, when the **boom** is at 90° to the mast.

13.4 The depth of the **boom**, including the sail track, forward of the **outer point** shall be 70mm ± 20mm and the width shall not exceed 37mm.

13.5 Spare number.

13.6 The **boom** shall be attached to the **mast** in such a way that the **mast** and the **boom** rotate as one.

14. **WEIGHT**

14.1 The hull, including all correctors, hatches and fittings permanently attached to it by screws, bolts, resin, or glue, and pulley blocks attached to the hull and dry control lines shall not weigh less than 72kg. The centreboard, rudder, floorboards, and mainsheet are excluded from the weight.

14.2 If the hull is found to weigh less than 72kg, correctors weighing a total not exceeding 5kg shall be fastened to the aft face of the station 2 bulkhead underneath and touching the side decks. The total weight of correctors shall be recorded on the certificate. No correctors shall be removed or altered without the boat being re-weighed by a measurer and the certificate amended in accordance with the procedures of the administering authority.

14.3 If the hull is found to require more than 5kg correctors, additional correctors of equal weight shall be attached to the underside of the deck at bow and transom. The total weight of correctors shall be recorded on the certificate. No correctors shall be removed or altered without the boat being re-weighed by a measurer and the certificate amended in accordance with the procedures of the administering authority.

15. SAIL

15.1 General

15.1.1 Anything not specifically permitted by these Class Rules is PROHIBITED.

15.1.2 Sails shall be made and measured in accordance with the ISAF ERS currently effective, except where varied herein, and with the RRS. Where a term defined or measurement given in the ERS is used in the Rules it is printed in '**bold**' type.

15.1.3 The manufacturer of sails is optional.

15.2 Construction

15.2.1 The construction of the sail shall be: **Soft sail, single ply sail.**

15.2.2 The body of the sail shall consist of the same woven ply throughout, however a footshelf of not more than 300 mm width is permitted to be of a different woven cloth. Primary reinforcement may consist of any material. Secondary reinforcement shall consist of the same material as used in the body of the sail. All woven ply fibres shall be polyester.

15.2.3 The following are permitted: stitching, glues, webbing, woven and PTFE tapes, corner eyes, a boomslide, headboard with fixings, one eye or not more than two blocks fixed to the sail to feed the Cunningham line through, **batten pocket** elastic, batten retaining devices, leech line with cleat, one **window**, sailmaker's labels and advertisements as permitted by the RRS, sail numbers, national letters and class insignia, tell tales. The **sail** shall have a **luff** and a **foot** bolt rope of not less than 80% of their respective lengths and which may be elastic, running in a track or groove on the aft side of the mast and the upper side of the boom.

15.2.4 The **leech** above the upper batten pocket, shall not extend beyond a straight line, drawn from the **aft head point** to the upper edge of the **upper batten pocket**.

15.3 Dimensions

	minimum	maximum
Leech length	mm	5425 mm
Half width	mm	1675 mm
Three-quarter width	mm	1040 mm
Top width	-	160 mm
Primary reinforcement	-	350 mm
Secondary reinforcement:		
from sail corner measurement points	-	1050 mm
for flutter patches	-	120 mm
for batten pocket patches	-	175 mm
Tabling width on luff and foot		60 mm
elsewhere		35 mm
Window area	-	0.28 m ²
Window to sail edge		150 mm
Extension of headboard from head point		160 mm
Batten pocket length:		

	minimum	maximum
uppermost and lowermost pockets: inside	-	585 mm
intermediate pockets: inside	-	735 mm
Batten pocket width: inside	-	60 mm
Head point to intersection of leech and centreline of uppermost batten pocket	1000 mm	1200 mm
Clew point to intersection of leech and centreline of lowermost batten pocket	1000 mm	1200 mm

15.4 The Class Insignia shall have a height of 200 mm and a width of 335 mm. National Letters and Sail Numbers shall comply with RRS Appendix G.1.2 (b).”

15.5 Additional Sail Rules

15.5.1 Only Sails endorsed in accordance with Class Rule 5 shall be used.

15.5.2 The **sail** shall be set so that the highest visible point at the **head** is lower than the **upper point** and so that the aft most visible part of the **leech** is forward of the **outer point**.

16. ADDITIONAL RULES WHICH APPLY WHILE RACING

16.1 Crew: One person shall be on board when racing.

16.2 Competitor Clothing and Equipment

The total weight of clothing and equipment worn or carried by a competitor shall not exceed 10 kg when weighed as provided in Appendix J of the RRS.

16.2 Anchor: An anchor need only be carried when specifically prescribed in the Sailing Instructions.

16.4 Pumping: In accordance with RRS 86.1(c), RRS 42.3(c) is amended as follows: On a free leg of the course, when surfing (rapidly accelerating down the leeward side of a wave) or planing is possible, the boat's crew may, in order to initiate surfing or planing, pump the sheet once for each wave or gust of wind. When the sail is pumped it shall be done through the bottom block with at least three parts of the mainsheet system.

16.5 Electronic Equipment: Electronic equipment which is only capable of providing timing and current compass direction is permitted.

16.6 Advertising is permitted in accordance with RRS Appendix 1, ISAF Advertising Code 20.3.1(b), Category C.

<u>OFFICIAL PLANS</u>	1.	General arrangement and Construction Details	1986
	2.	Full Size Details	1986

Appendix A

Amendment: Add new Appendix A - Definitions as follows:

Appendix A Definitions

A.1 Materials

- (i) Where used the abbreviation GRP is defined as glass fibre reinforced polyester.
- (ii) Where used the abbreviation GRE is defined as glass fibre reinforced epoxy.
- (iii) Where used the abbreviation CRE is defined as carbon fibre reinforced epoxy.
- (iv) Where used the abbreviation CRP is defined as carbon fibre reinforced polyester.

Appendix B

Sail makers are allowed on request and single (i.e. per sail) approval by the Technical Committee of OKDIA to build sails from laminated sail cloth. The use of those sails is allowed in any OK regatta with the exception of International events. For the purpose of this rule an event is an International Event when its aim is competition between competitors from more than one MNA. An Official Measurer is allowed to ignore rule 15.2.1, 15.2.2 and from 15.3 all dimensions with the exception of (all) leech lengths, half width, three quarter width and top width, if the approval document from OKDIA is presented when measuring.