

OKDIA

# 2004 INTERNATIONAL OK DINGHY CLASS RULES



I S A F

Authority\*: International Sailing Federation

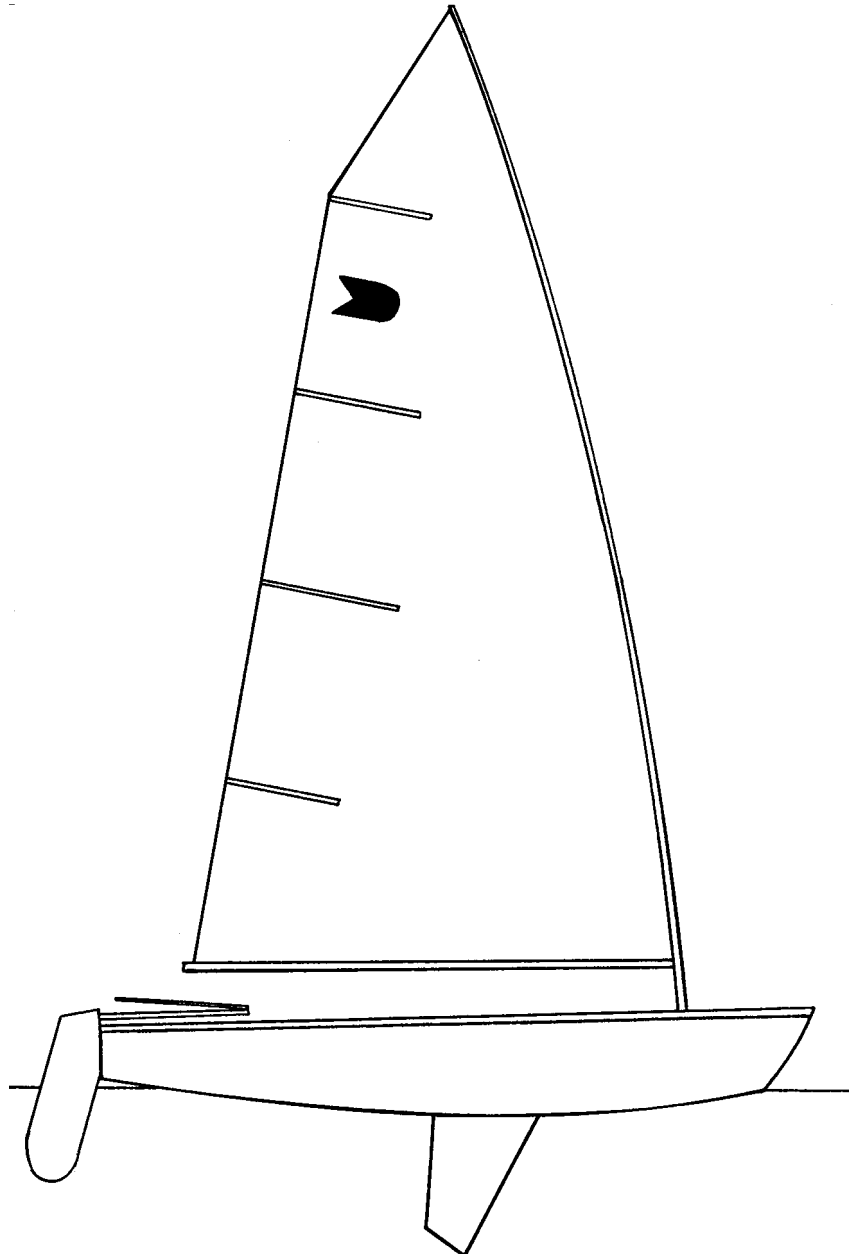

\* The International Sailing Federation (ISAF) is not a National Authority (NA).

## **1. GENERAL**

- 1.1 The OK Dinghy is a one-design class. The intention of these rules is to ensure that the boats are as alike as possible in all respects affecting performance. However, within these rules, variations in the construction of the boat are permitted.
- 1.2 The official language of the class is English, and in the event of dispute over interpretation the English text shall prevail.
- 1.3 These rules are complementary to the plans, measurement form and measurement diagram. Any interpretation shall be made by the ISAF which shall consult the OK Dinghy International Association (OKDIA).
- 1.4 In the event of discrepancy between these rules, the measurement form, the measurement diagram and/or the plans the matter shall be referred to the ISAF.
- 1.5 All boats shall be built in accordance with the class rules and measurement form as issued by the ISAF.
- 1.6 In countries where there is no National Authority (NA) or the NA does not wish to administer the class, its functions as stated in these class rules shall be carried out by OKDIA or its delegated representatives (National Associations). Where the NA has delegated the administration of the class to the National Association the words "National OK Dinghy Association" replace the words "National Authority" in the following rules.
- 1.7 Neither the ISAF nor OKDIA accept any legal responsibility in respect of these rules and/or the plans or any claim arising therefrom.

## **2. BUILDERS**

The OK Dinghy may be built by any professional or amateur builder; no building licence is required.

## **3. BUILDING FEE**

- 3.1 The building fee shall be subject to review by ISAF and OKDIA
- 3.2 The amount of the International Class Fee may be reviewed by the ISAF in consultation with OKDIA.
- 3.3 OKDIA is responsible for the collection and distribution of building fees.
- 3.4 The building fee is payable by the builder on each boat built, whether or not it is subsequently measured and registered. Payment shall be made directly to the National OK Dinghy Association which shall issue a receipt and an ISAF plaque, both bearing the same number. The receipt and plaque shall be delivered by the builder to the owner on sale of the boat. The plaque should be fitted on the starboard side of the aft cockpit bulkhead.
- 3.5 Building fee receipts shall be valid only if made out on official receipts issued by OKDIA. The ISAF will sell these receipts for the agreed fee to the OKDIA which shall sell them for a fee approved by the ISAF to each of its National Associations. The purchase price in each case represents the proportion of the building fee due to the ISAF and the OKDIA and the National Association.

#### **4. REGISTRATION AND MEASUREMENT CERTIFICATE**

- 4.1 No boat is permitted to race in the class unless it has a valid measurement certificate.
- 4.2 The certificate is only valid for racing if the owner is a current member of a National OK Dinghy Association.
- 4.3 The certificate is obtained as follows:
- (i) The builder or owner shall apply to the National Authority for a sail number enclosing the building fee receipt. The National Authority shall issue a sail number only on receipt of evidence that the building fee has been paid.
  - (ii) The boat shall be measured by a measurer officially recognised by the NA. The completed measurement form shall be supplied to the owner of the boat.
  - (iii) The owner shall send the completed measurement form to his NA together with any registration fee that may be required. On receipt of this the NA may issue a certificate to the owner.
- 4.4 Change of ownership invalidates the certificate but shall not necessitate remeasurement. The owner may apply to his NA for a new certificate returning the old certificate together with any re-registration fee that may be required and stating the necessary particulars. A certificate shall then be issued to the new owner.
- 4.5 It is the owner's responsibility to ensure that his boat, spars, sails and equipment comply with the class rules at all times and that alterations or repairs to the boat, spars, sails or equipment do not invalidate the certificate.
- 4.6 Notwithstanding anything in these rules the ISAF or NA shall have the power to refuse to grant a certificate to, or withdraw a certificate from, any boat.
- 4.7 OKDIA shall be sent at regular intervals from each NA details of certificates issued, together with the names and addresses of the owners.

#### **5. MEASUREMENT**

- 5.1 Only a measurer officially recognised by a NA shall measure a boat, its spars, sails and equipment and sign the declaration on the measurement form that they comply with the class rules.
- 5.2 The measurer shall report on the measurement form anything which he considers to be a departure from the intended nature and design of the boat, or to be against the general interest of the class, and a certificate may be refused, even if the specific requirements of the rules are satisfied.
- 5.3 A measurer shall not measure a boat, spars, sails or equipment owned or built by himself, or in which he is an interested party or has a vested interest.
- 5.4 New or substantially altered sails shall be measured by an official measurer who shall stamp or sign and date the sails near the tack.
- 5.5 All boats in hull form and construction, spars and sails shall comply with the current rules or

with the corresponding rules applying to them at the time the original certificate was issued. Any alterations or replacements shall comply with the current rules.

- 5.6 All boats and their equipment shall be liable to re-measurement at the discretion of the NA or race committee.
- 5.7 All boats will be liable to gyration tests at the discretion of the National Authority or race committee. If necessary, additional blocks shall be attached to the boat if there is no sheerguard, or if the sheerguard is inadequate, to engage swing hooks.

## **6. IDENTIFICATION MARKS**

- 6.1 The hull of all boats built after 1st September 1973 shall carry the sail numbers and national letters either cut out or burned into the hog or centreboard case in the cockpit, or on the bulkhead at station 2 on centreline, in figures not less than 20mm in height.
- 6.2 The sail shall carry identification marks as indicated in rule 15.4.
- 6.3 All emblems, marks and numbers shall be of a durable material and securely attached.

## **7. HULL MEASUREMENT**

- 7.1 As many measurements as considered practical to check the shape have been listed on the measurement form, but the intention is that in all particulars the boats shall conform to the designed shape.
- 7.2 Length measurements of the hull shall be taken parallel to the base line and depth measurements perpendicular to the base line. Measurement sections including the aft edge of the transom shall be perpendicular to the base line.

## **8. CONSTRUCTION**

- 8.1 The hull, decks and centreboard case shall be made of wood or glass fibre reinforced resin (GRP) or a combination of these materials. GRP sandwich construction, not exceeding 25mm thickness including stringers, is also permitted. Wood used shall be of durable nature.
- 8.2 Any holes in buoyancy tanks shall be made watertight and each buoyancy tank shall have at least one and not more than three inspection holes of diameter not less than 85mm. Each hole shall have a detachable cover capable of resisting accidental dislodgement and such covers shall be positively secured at all times when racing. Covers to holes in the bulkheads shall not extend into the buoyancy compartments by more than 200mm. Control lines passing through buoyancy compartments shall be inside watertight tubes capable of withstanding the normal wear and tear and remaining watertight. The sum total cross sectional area of these tubes shall not exceed 150 cm<sup>2</sup> and they shall be within 350mm of the centreline of the boat. Control lines passing through the bulkheads or decks shall be within 350mm of the centreline of the boat.
- 8.3 Construction of the hull, with the exception of stringers, shall be of approximately even thickness (within 10%) and density longitudinally and no attempt shall be made to concentrate weight near mid-length, or at any other point. If it is suspected that this rule is being broken a NA may order test holes to be drilled in the skin or structure.

8.4 The following shall conform with:

- (i) There shall be three watertight bulkheads. The forward face of the aft bulkhead shall be  $800\text{mm} \pm 15\text{mm}$  and the aft face of the forward cockpit bulkhead shall be  $1794\text{mm} \pm 15\text{mm}$  from the lowest point of the aft face of the transom. A bulkhead at, or forward of, station 3 ( $2800\text{mm}$  from the aft face of the transom) and aft of the mast shall be fitted in all boats first measured after 1st March 1984. This bulkhead may have a hatch with a watertight cover.
- (ii) The radius between the bulkheads and the side or bottom panels of the hull shall not exceed  $50\text{mm}$ .
- (iii) Drain holes from the forward buoyancy compartment to the cockpit through the bulkhead at station 2 ( $\pm 15\text{mm}$ ) shall not exceed two in number, and each shall be of not more than  $20\text{mm}$  in diameter and shall be closed while racing. There shall not be more than two drain holes into the aft buoyancy tank. They shall be made through the bulkhead at station 1 ( $\pm 15\text{mm}$ ) and shall each be of not more than  $20\text{mm}$  in diameter and shall be closed while racing.

The mast compartment shall drain into the cockpit through a tube of diameter not less than  $10\text{mm}$  and not more than  $20\text{mm}$ .

- (iv) The horizontal width of each side deck, measured from the sheerline, shall be not more than  $240\text{mm}$  or less than  $120\text{mm}$ .
- (v) The side deck and/or carlin shall nowhere be higher than  $40\text{mm}$  above nor  $80\text{mm}$  below the sheerline. Struts to support the side deck are permitted but shall not exceed a total cross-sectional area of  $50\text{cm}^2$  per side, measured horizontally.
- (vi) The sheerline between stations 1 and 2 shall not be convex.
- (vii) At the centreline of the mast, the deck shall be  $30\text{mm} \pm 10\text{mm}$  above the sheerline. Measured athwartships the fore and aft decks shall not be concave.
- (viii) A sheerguard, not exceeding  $35\text{mm}$  horizontally from the sheerline by  $35\text{mm}$  vertically, may be fitted.
- (ix) Between station 3 and the transom, the radius on the chines shall not exceed  $15\text{mm}$ .
- (x) The horizontal distance from the lowest point of the aft face of the transom to the centre of the centreboard bolt shall be  $2400\text{mm} \pm 10\text{mm}$ .
- (xi) Spare number.
- (xii) The mast step and deck bearing may be adjustable but shall not be adjusted while racing.
- (xiii) A keel band, minimum section  $9\text{mm}$  wide by  $3\text{mm}$  deep, maximum section  $22\text{mm}$  wide by  $10\text{mm}$  deep, of any material shall extend for a distance not less than  $3500\text{mm}$ , measured along the keel band, from the aft face of the transom. The radius of the bow forward of a point  $3500\text{mm}$  from the lowest point of the aft face of the transom, measured along the base line, shall not exceed  $11\text{mm}$ .

- (xiv) Centreboard slot rubbers are prohibited.
  - (xv) Hiking pads may be attached to the side decks, provided that they fall within the measurements prescribed by rules 8.4(iv), 8.4(v) and 8.4(viii). However, notwithstanding the provisions of rule 8.4(vi) padding up to 10mm thick is permitted to cover the sheerline measured at 90° to the surface.
  - (xvi) A towing eye shall be fitted to the foredeck near the stemhead.
- 8.5 With the boat set up for measuring and with the base line horizontal the transom shall be not more than 12mm out of vertical.
- 8.6 8.6 The length of the hull, excluding deck overlap but including stem band, if any, shall be 4000mm ± 10mm measured from the lowest point of the transom.
- 8.7 Measurement stations 1, 2, and 3 shall be at 800mm, 1800mm and 2800mm respectively from the lowest point of the aft face of the transom measured along the base line.
- 8.8 To check the profile of the keel, a baseline shall be positioned below the hull at distances from the bottom of the hull of 200mm at station 'O' and 28mm at station '3'. The bottom of the hull shall be the point at which the extensions of the surfaces of the panels intersect. The measurements shall be in the plane of the measurement stations.
- 8.9 A straight edge placed on the bottom panel at right angles to the centreline at stations 0, 1, 2 and 3 shall not exceed the distances from the bottom panel shown on the measurement diagram. A straight edge placed at right angles to the base line on the topside panel shall not be further than 8mm from the topside panel at any point. This measurement shall be made between the sheerline and the chine and not from the underside of the sheerguard.
- 8.10 The surface of the hull shall be checked with a flexible batten to ensure that the curvature of the hull is fair.
- 8.11 A breakwater may be fitted between the mast and the mainsheet horse or track.
- 8.12 The types, positions and arrangement of floor boards, fittings, self-bailers, sheeting and centreboard hoists are free. The mainsheet track may extend outboard to the topside panel. If the side-deck profile is cut away for this purpose the panel on which the track sits must satisfy rules 8.4(iv) and 8.4(v).

# MEASUREMENT DIAGRAM

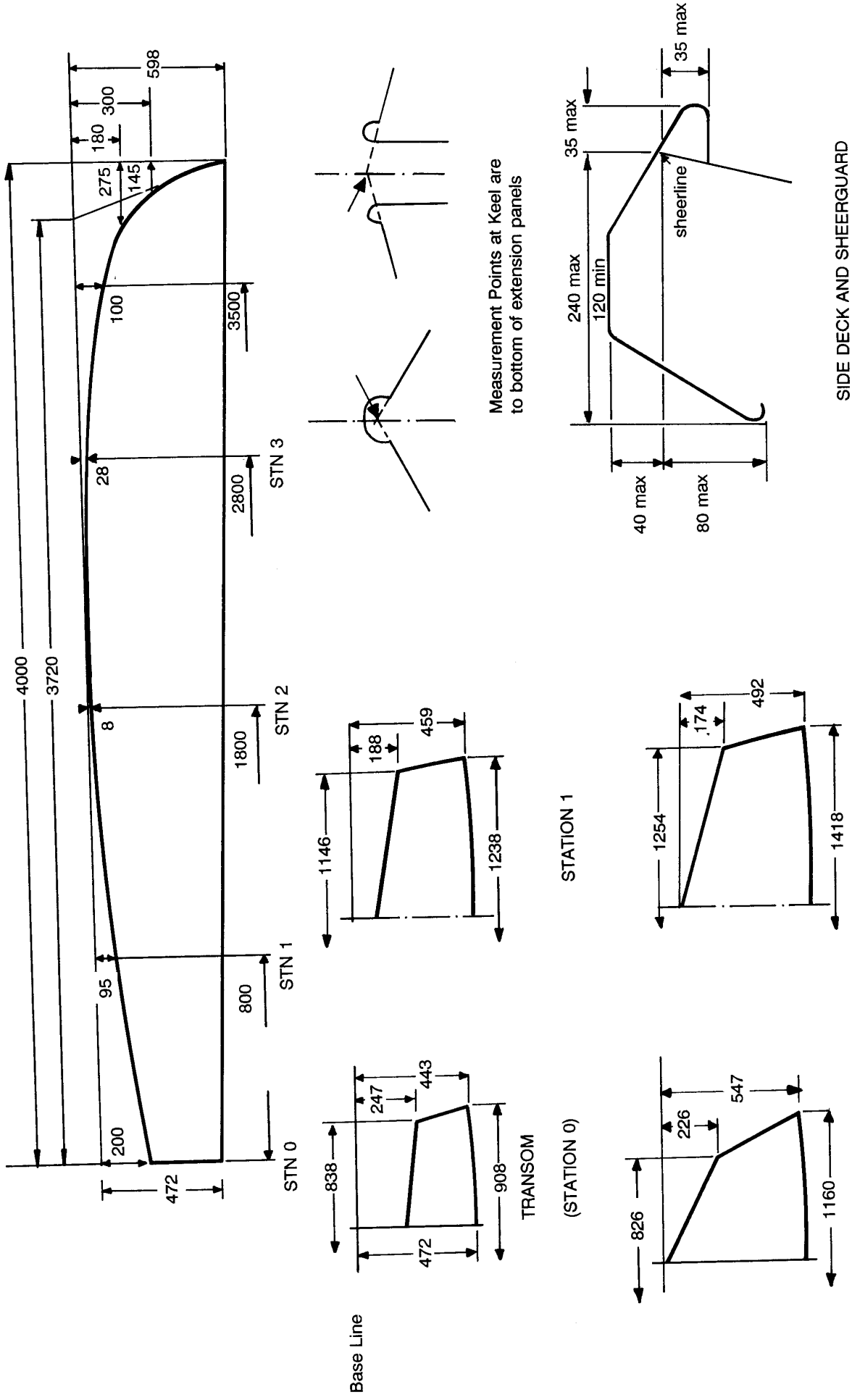

Base Line

TRANSOM

(STATION 0)

STATION 1

STATION 2

STATION 3

Measurement Points at Keel are to bottom of extension panels

SIDE DECK AND SHEERGUARD

## **9. BUOYANCY**

- 9.1 All the space aft of the cockpit shall form a buoyancy compartment. The space forward of the cockpit shall be occupied by not less than 0.12 m<sup>3</sup> of closed cell expanded plastic foam material properly secured. Sandwich construction shall not be regarded as buoyancy for the purposes of this rule. Wooden boats first measured before 1st March 1980 in which the space forward of the cockpit is occupied by two compartments, each not less than 0.12 m<sup>3</sup> in volume, are not required to have 0.12 m<sup>3</sup> of expanded plastic foam material forward of the cockpit.
- 9.2 Additional buoyancy within the cockpit area is permitted under the side decks to a point not lower than 80mm below the sheerline. This buoyancy shall not be included in the requirements of rule 9.1.
- 9.3 At first measurement the measurer shall check the watertightness of buoyancy tanks, inspection ports and drain plugs. If the buoyancy is unsatisfactory the measurer shall not sign the measurement form until successful remedial measures have been taken.

## **10. CENTREBOARD**

- 10.1 The centreboard shall be made of metal wood and/or foam cored GRP except that a protecting strip of any material is permitted. Wood centreboards may be covered with GRP.
- 10.2 The thickness of the centreboard shall not exceed 20mm, including GRP sheathing if any, if made of wood and 6mm maximum if of metal.
- 10.3 Excluding any pivot slot, the profile of the measured part of the centreboard shall be within two lines, one 5mm outside, and the other 5mm inside the profile shown on the measurement diagram, when the pivot point in the centreboard lies on the pivot point shown on the measurement diagram.

A slot may be made between the pivot point in the centreboard and the perimeter. The slot shall be nowhere wider than 12mm. A device of adequate strength shall be fitted to prevent accidental dislodgement. Maximum free movement of the centreboard on the pivot bolt shall be 2mm in any direction.

- 10.4 When the centreboard is fully raised it shall not project below the keel bands.
- 10.5 The extension of the centreboard below the keel, excluding the keelband, shall not exceed 800mm. A stop shall be fitted to prevent this dimension being exceeded.



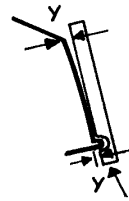
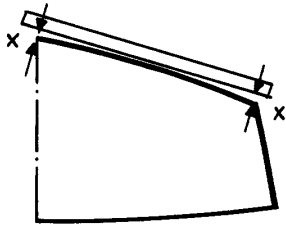

curvature of side panel Y is not to exceed 8mm

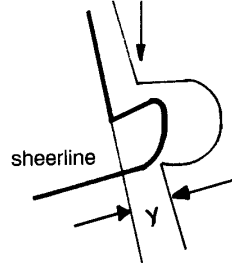

Station	Distance from bottom panel to straight edge (X in diagram)	
Transom	15mm	maximum
Station 1	25mm	maximum
Station 2	30mm	maximum
Station 3	35mm	maximum

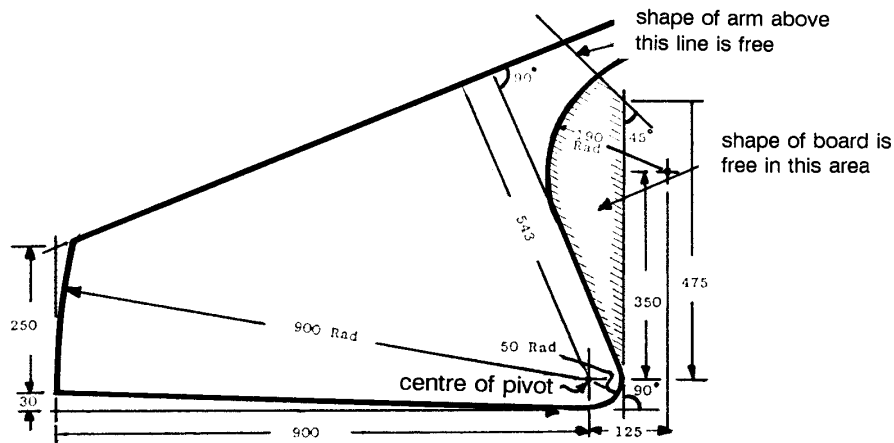

CENTREBOARD

## 11. **RUDDER BLADE**

- 11.1 The rudder blade shall be made of wood and/or foam covered GRP except that a protecting strip of any material is permitted. The blade may be covered with GRP.
- 11.2 The thickness of the rudder blade below the waterline shall not exceed 20mm, including GRP covering (if any).
- 11.3 (a) The measured part of the rudder blade shall be within two lines, one 5mm outside and the other 5mm inside one of the two profiles shown on the measurement diagram.

(b)

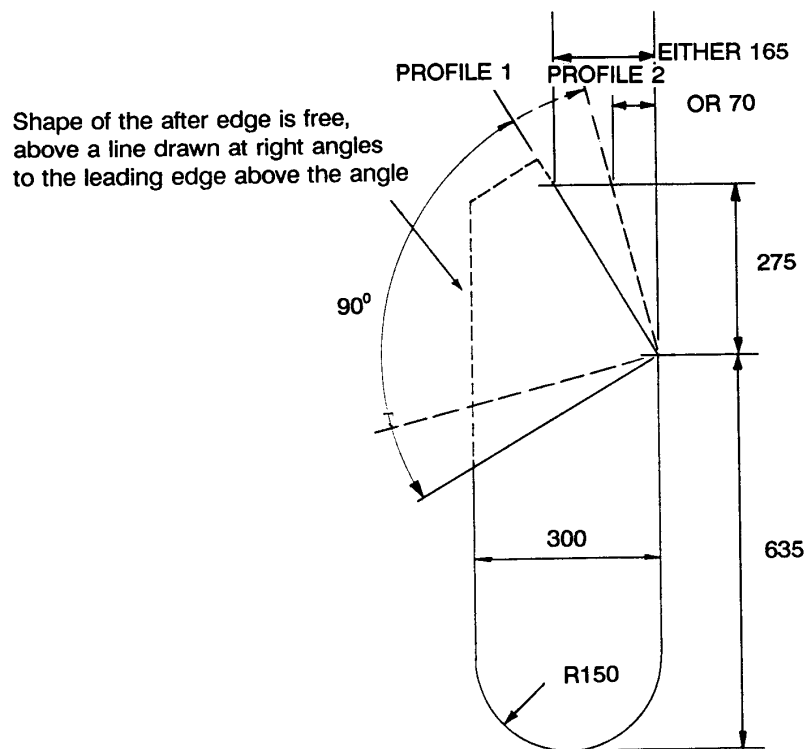

- 11.4 Lifting rudder blades shall be pinned or bolted in the down position during racing in a separate place from the point at which the rudder blade pivots.
- 11.5 The distance between the foreside of the rudder or its extension and the transom shall be measured at deck level and at the keel. Neither measurement shall exceed 45mm and the difference between the two measurements shall not exceed 5mm. The intersection of the leading edges of the rudder shall not be lower than 50mm below the transom.
- 11.6 A safety device shall be fitted so that the rudder cannot come off its pintles unintentionally if the boat is inverted.

## 12. **MAST**

### 12.1 Materials

The **spar** shall be made of wood, aluminium alloy, plastic or any combination of these. For the purpose of rule 12 plastic is defined as glass fibre, carbon fibre, aramid, polyester resin or epoxy resin. An external sail track may be of any material.

### 12.2 Construction

The construction of the **mast** is optional, with the following exceptions:

- (i) The aft side of the sail track or groove shall be constructed straight and the line of the track or groove, extended if necessary, shall be not more than 10mm outside the aft edge of the bearing ring at the deck.
- (ii) **Mast spar curvature** at any point 50mm maximum.
- (iii) Any cross section shape of a plastic **spar** shall be in principle round, oval or teardrop and shall have no hollows with the exception of the sail track or groove.

### 12.3 Fittings

With the exception of wooden **spars**, the **boom** shall be attached to the **spar** by a fixed fork

fitting. The width between the arms of the fork shall be 38mm +/- 2mm. The boom pinholes shall be 16mm +/- 2mm in diameter. The centre of the holes shall be situated 37mm +/- 2mm aft of the aft face of the **spar** and 35mm +/- 2mm below the **lower point**.

#### 12.4 Dimensions

	minimum	maximum
<b>Lower point height</b> above deck	265mm	275mm
<b>Upper point height</b> above <b>lower point</b>		5400mm
<b>Mast datum point</b> below <b>lower point</b>		270mm
Centre of gravity above <b>mast datum point</b>	1700mm	
TRANSVERSE Cross Section		
From <b>heel point</b> to 1000mm above <b>mast datum point</b> .	62mm	
From 1000mm above <b>mast datum point</b> to <b>upper point</b> the minimum dimension is given by a uniform reduction of 1mm for every 100mm.		

#### FORE-AND-AFT Cross Section

From **heel point** to **upper point** the maximum dimension is given by the actual transverse width at the same height

<b>Lower limit mark width</b>	10mm	plus 22mm
<b>Upper limit mark width</b>	10mm and all above <b>upper point</b>	
Diameter at deck level including the optional bearing ring if fitted	94mm	98mm
Diameter at 20mm above <b>heel point</b> including the optional bearing ring if fitted	70mm	76mm
<b>Mast spar curvature</b> at any point		50mm

#### 12.5 Weight

The **spar weight** including all fixed fittings in their normal racing position shall be not less than 8kg. Lead **Corrector weights** totaling not more than 0.6kg permanently fixed above deck to the exterior face of the **spar** are permitted.

#### 12.6 Mast sail limit marks

The **mast sail limit marks** shall be in a contrasting colour to the **masts** colour and shall be clearly visible while racing.

#### 12.7 Use

- (i) Movement of the **mast**, either at deck or at **heel point**, shall not exceed 7mm.
- (ii) There shall be a security device of adequate strength such that the **mast** will not come out of the step when the **boat** is capsized."

### 13. **BOOM**

13.1 The **boom** shall be made of wood, aluminium alloy, GRP or any combination of these materials. The sail track may be of any material

13.2 An **outer limit mark** of a distinctive colour not less than 10mm wide shall be marked on the **boom** so it is clearly discernible when racing, with its forward edge not more than 2680mm from the aft edge of the **mast spar** projected if necessary to the **boom**. A device shall be fitted to the **boom** to prevent any part of the **sail** extending aft of the forward edge of the **outer limit mark**.

- 13.3 The top of the **boom** including its sail track, extended if necessary, shall not be below the **lower point**, when the **boom** is at 90° to the mast.
- 13.4 The depth of the **boom**, including the sail track, forward of the **outer point** shall be 70mm ± 20mm and the width shall not exceed 37mm.
- 13.5 Spare number.
- 13.6 The **boom** shall be attached to the **mast** in such a way that the **mast** and the **boom** rotate as one.

## 14. **WEIGHT**

- 14.1 The hull, including all correctors, hatches and fittings permanently attached to it by screws, bolts, resin, or glue, and pulley blocks attached to the hull and dry control lines shall not weigh less than 72kg. The centreboard, rudder, floorboards, and mainsheet are excluded from the weight.
- 14.2 If the hull is found to weigh less than 72kg, correctors weighing a total not exceeding 5kg shall be fastened to the aft face of the station 2 bulkhead underneath and touching the side decks. The total weight of correctors shall be recorded on the certificate. No correctors shall be removed or altered without the boat being re-weighed by a measurer and the certificate amended in accordance with the procedures of the administering authority.
- 14.3 If the hull is found to require more than 5kg correctors, additional correctors of equal weight shall be attached to the underside of the deck at bow and transom. The total weight of correctors shall be recorded on the certificate. No correctors shall be removed or altered without the boat being re-weighed by a measurer and the certificate amended in accordance with the procedures of the administering authority.

## 15. **SAIL**

### 15.1 General

15.1.1 Anything not specifically permitted by these Class Rules is PROHIBITED.

15.1.2 Sails shall be made and measured in accordance with the ISAF ERS currently effective, except where varied herein, and with the RRS. Where a term defined or measurement given in the ERS is used in the Rules it is printed in '**bold**' type.

15.1.3 The manufacturer of sails is optional.

### 15.2 Construction

15.2.1 The construction of the sail shall be: **Soft sail, single ply sail.**

15.2.2 The **sail** shall have 4 **batten pockets** in the **leech**.

15.2.3 The following are permitted: stitching, glues, webbing, woven and PTFE tapes, bolt ropes (which may be of elastic shock cord) on the **luff** and the **foot**, corner eyes, a boomslide, headboard with fixings, Cunningham eye, batten pocket elastic, batten retaining devices,

leech line with cleat, one **window**, sailmaker's labels and advertisements as permitted by the RRS, sail numbers, national letters and class insignia, tell tales.

15.2.4 The **leech** above the upper batten pocket, shall not extend beyond a straight line, drawn from the **aft head point** to the upper edge of the **upper batten pocket**.

### 15.3 Dimensions

	Minimum	maximum
<b>Leech length</b>		5425
<b>Half width</b>		1675
<b>Three quarter width</b>		1040
<b>Top width</b>		160
<b>Primary reinforcement</b>		350
<b>Secondary reinforcement</b>		
<b>points</b> from <b>corner measurement</b>		1050
		for <b>flutter patches</b>
		for <b>batten pocket patches</b>
<b>Tabling width</b> on luff and foot		60
		elsewhere
		35
<b>Window area</b>		0.28m <sup>2</sup>
Shortest distance of <b>window</b> to <b>edge of sail</b>	150	
Greatest dimension of <b>headboard</b> from <b>head point</b>		160
<b>Batten pocket length</b>	Minimum	maximum
		uppermost and lowermost, inside
		585
		outside
		605
		intermediate, inside
		735
		outside
		755
<b>Batten pocket width</b> inside		60
		outside
		100
<b>Headpoint</b> to intersection of <b>leech</b> and centreline of uppermost <b>batten pocket</b>	1000	1200
<b>Clewpoint</b> to intersection of <b>leech</b> and centreline of lowermost <b>batten pocket</b>	1000	1200

### 15.4 Class Insignia, National Letters and Sail Numbers

Numbers and letters shall be of the following dimensions:	Minimum	maximum
Height	300	
Width	200	
Thickness	40	50
Spacing	60	
Class Insignia: height	200	
length	335	

15.5 Additional Sail Rules

15.5.1 Only Sails endorsed in accordance with Class Rule 5 shall be used.

15.5.2 The **sail** shall be set so that the highest visible point at the **head** is lower than the **upper point** and so that the aft most visible part of the **leech** is forward of the **outer point**.

**16. ADDITIONAL RULES WHICH APPLY WHILE RACING**

16.1 Crew: One person shall be on board when racing.

16.2 Competitor Clothing and Equipment

The total weight of clothing and equipment worn or carried by a competitor shall not exceed 10 kg when weighed as provided in Appendix J of the RRS.

16.2 Anchor: An anchor need only be carried when specifically prescribed in the Sailing Instructions.

16.4 Pumping: In accordance with RRS 86.1(c), RRS 42.3(b) is amended as follows: On a free leg of the course, when surfing (rapidly accelerating down the leeward side of a wave) or planing is possible, the boat's crew may, in order to initiate surfing or planing, pump the sheet once for each wave or gust of wind. When the sail is pumped it shall be done through the bottom block with at least three parts of the mainsheet system.

16.5 Electronic Equipment: Electronic equipment which is only capable of providing timing and current compass direction is permitted.

16.6 Advertising is permitted in accordance with RRS Appendix 1, ISAF Advertising Code 20.3.1(b), Category C.

<b><u>OFFICIAL PLANS</u></b>	1. General arrangement and Construction Details	1986
	2. Full Size Details	1986

